

Universal Heat Sink for AMP-L Amplifier Modules

Features

- compact and rugged design
- suitable for all AMP-L modules
- holes for mounting in housings
- intended for passive and active cooling with fans

Applications

- test setup evaluation
- amplifier evaluation
- laboratory applications
- TX amplifiers
- jammers
- base stations



application example

At a Glance

Universal heat sink UHS-1 is a compact heat sink for cooling of medium and high-power amplifier modules from of Becker Nachrichtentechnik.

Up to two different AMP-L modules can be flexibly attached to the flat side of the heat sink. With the option of installing up to six fans, high cooling performance can be achieved. If active cooling is required for the customer application, the cooler will be delivered with pre-installed fans. The heatsink is also supplied individually prepared with captive screws depending on customer requirements. On the bottom side is has holes for mounting in housings by the customer.

With most AMP modules from Becker Nachrichtentechnik, the speed of the fan is controlled via the temperature of the amplifier. This gives the cooling structure a very stable temperature condition.

The universal heatsink is made of natural finished aluminum and has a low thermal resistance.

Specification

Parameter	Symbol	Min.	Typ.	Max.	Unit	
thermal resistance	R_{TH-P}		0.5		K/W	passively cooled
	R_{TH-A}		0.25		K/W	actively cooled with 3 fans
	R_{TH-A}		0.13		K/W	actively cooled with 6 fans
dimensions	W x H x D	approx. 250 x 49 x 120			mm	
weight	m		2.0		kg	
		UHS-1		2200.550M.1	Universal Heat Sink	

Appearances

Application example: Universal Heat Sink with fans and one mounted amplifier module



Perspective view

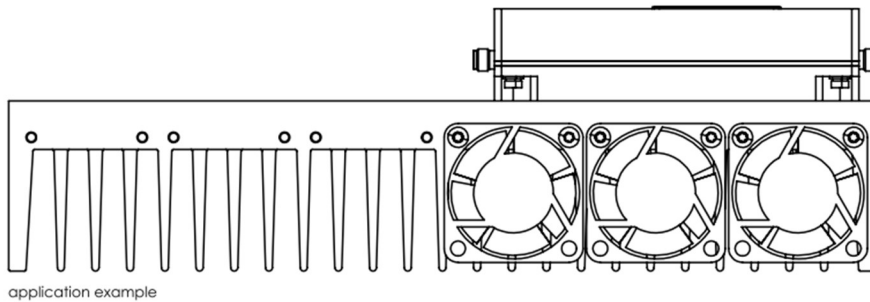

Side view

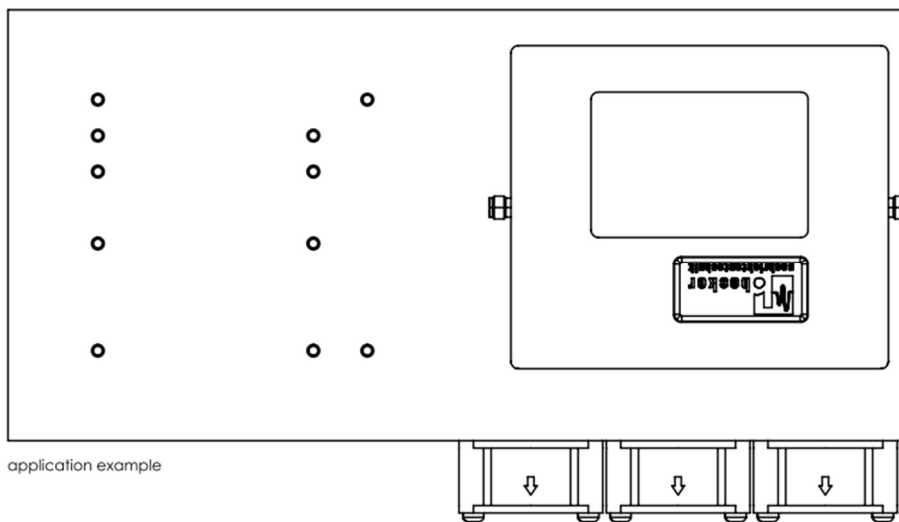

Top view

Application example: Universal Heat Sink with fans and two mounted amplifier modules



Perspective view

Application example: Universal Heat Sink passively cooled with one amplifier module

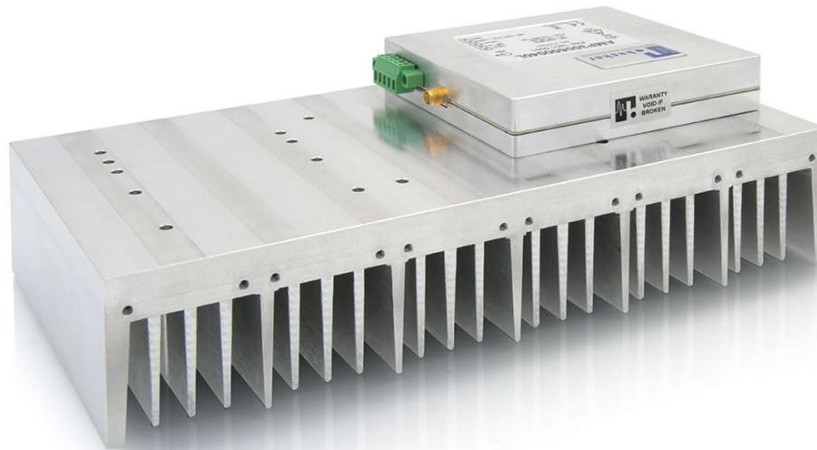

Perspective view

Dimensions

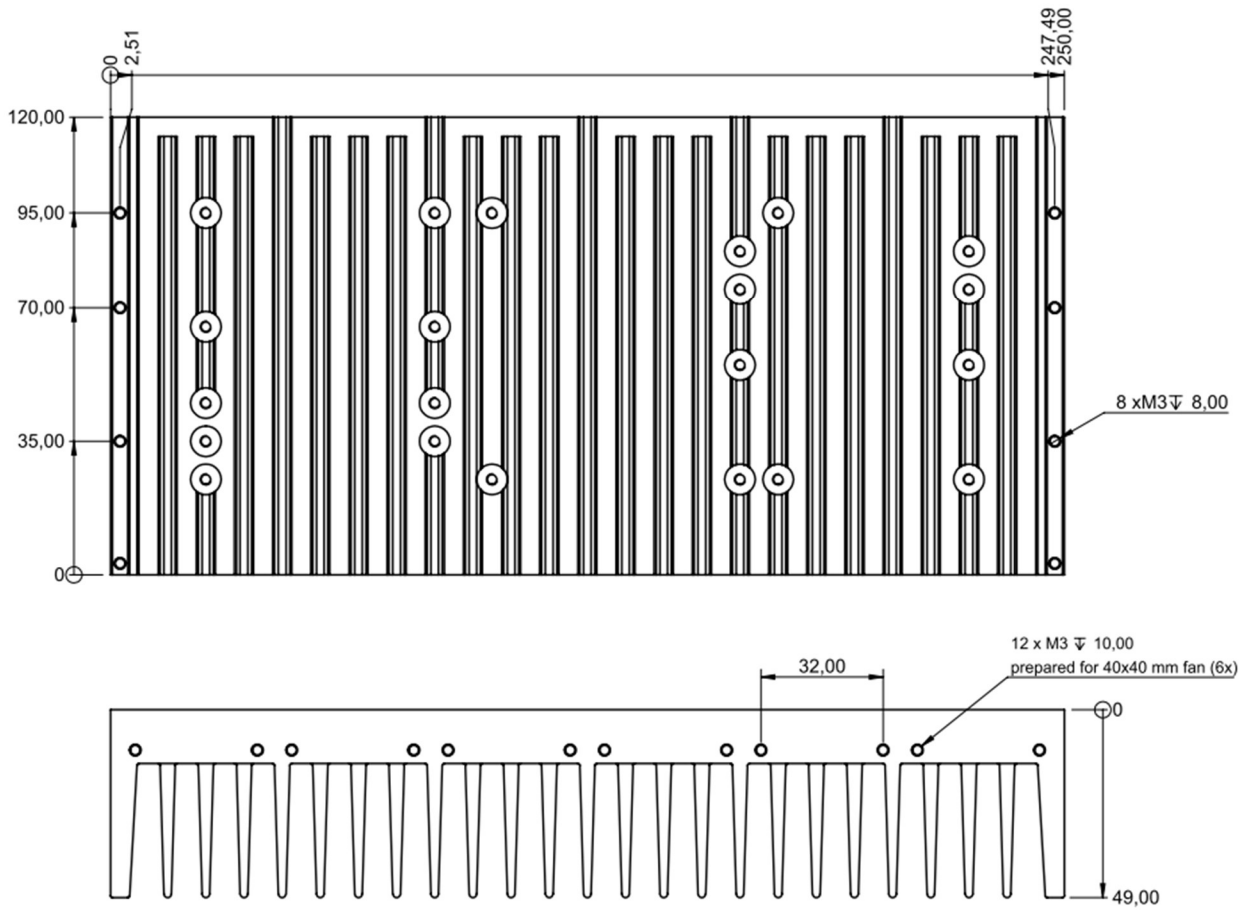

Mounting Patterns

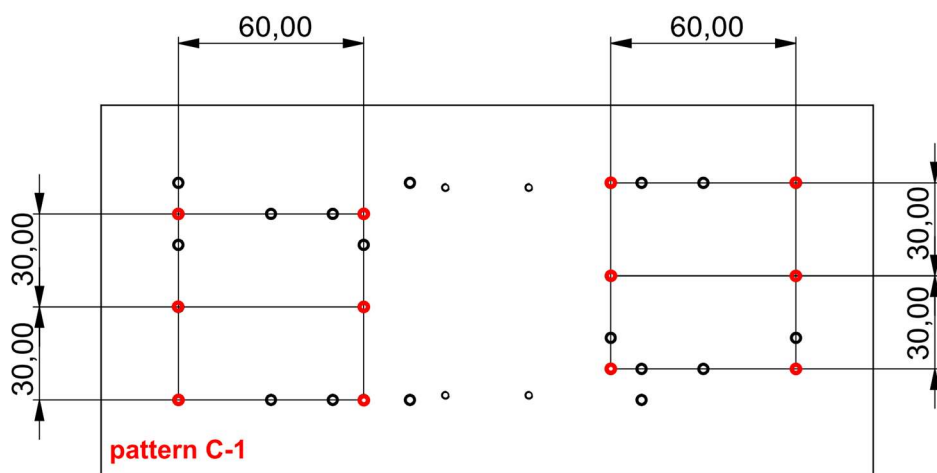
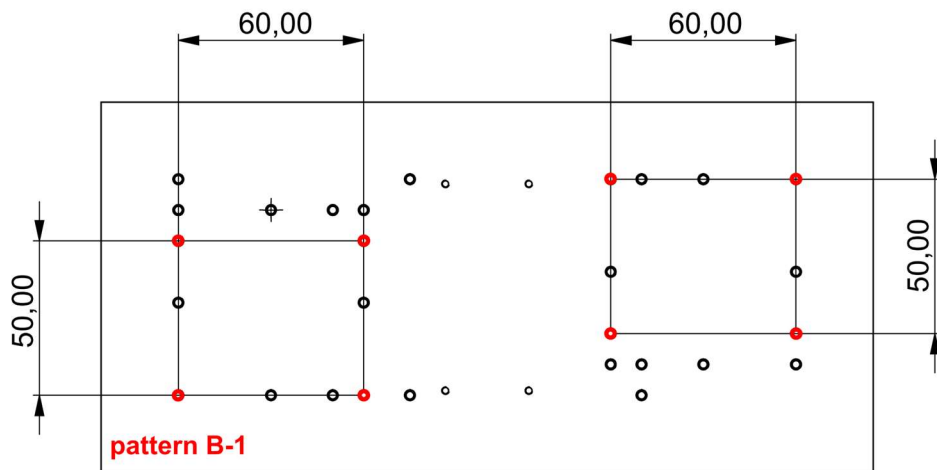
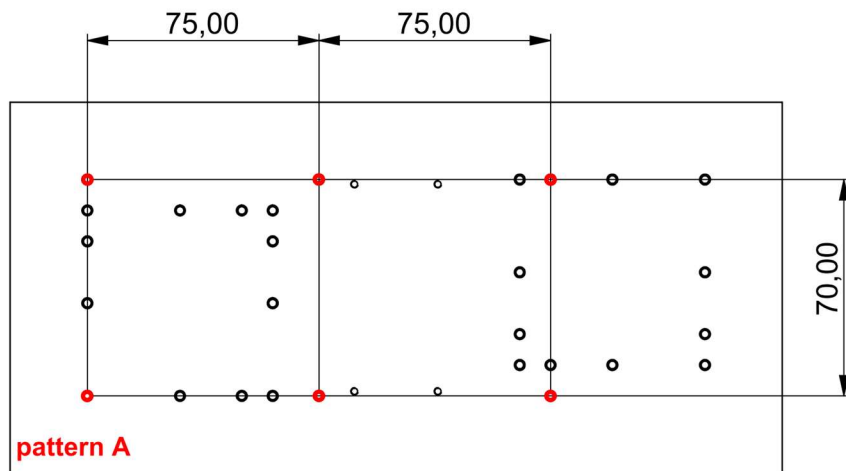

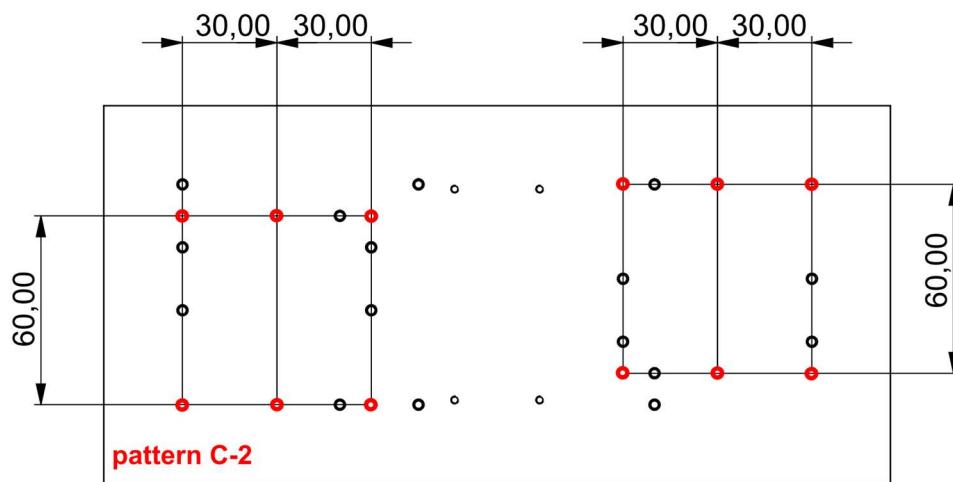
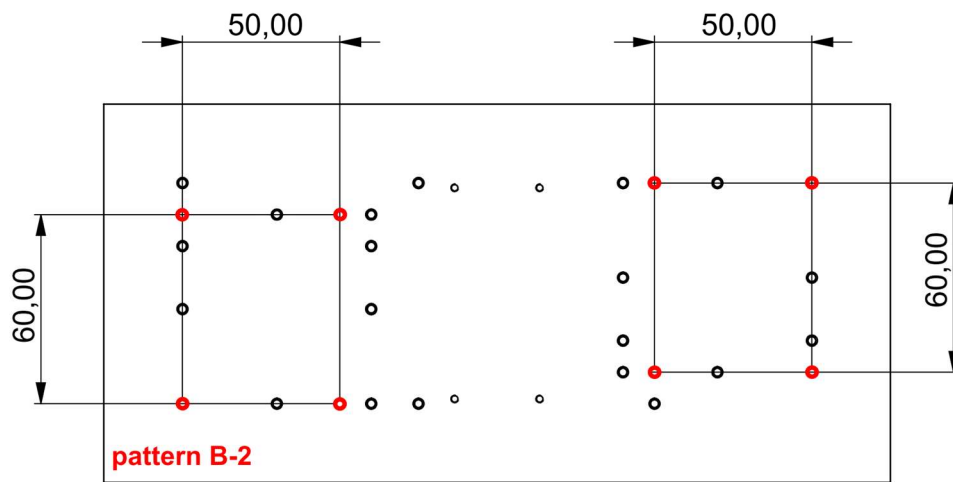

Related Products (mountable on Universal heat Sink)

Product	Description	P/N
AMP7610849L	80 W FM Linear Power Amplifier Module, 76...108 MHz <i>Mounting pattern C</i>	2104.5001.3
AMP17024048L	60 W DAB Linear Power Amplifier Module, 170...240 MHz <i>Mounting pattern C</i>	2104.5001.4
AMP1053045	30 W Linear Power Amplifier Module, 10...530 MHz <i>only single channel use, Mounting pattern A</i>	1908.5001.1
AMP300600040L	10 W Power Amplifier Module, 300...6000 MHz <i>Mounting pattern B</i>	1801.5001.1
AMP17001300038L	6 W Power Amplifier Module, 1700...13000 MHz <i>Mounting pattern B</i>	2004.5011.1
AMP20002000042L	15 W Power Amplifier Module, 2000 MHz ... 20 GHz <i>Mounting pattern B</i>	2301.5101.1

